

## **10th Standard Science**

### **Chapter 12 - Electricity**

#### **Introduction**

Electricity originated from the Greek words “Electrica” and “Elektron”.

The Greek Philosopher Thales was the first to observe the attracting capacity of certain materials when rubbed on other materials.

Gilbert classified these materials as Vitreous and Resinous.

These names were later changed to positive and negative charges.

#### **Frictional Electricity**

Fur, Flannel, Wax, Glass, Cotton, Paper, Silk, Human skin, Wood, Metals, Rubber, Resin, Amber, Sulphur, Ebonite.

If any two materials in this series are rubbed against each other the element occurring first in series will acquire positive charge and the element occurring later will acquire negative charge.

#### **Fundamental Laws of Electrostatics**

There are two kinds of charges- positive and negative.

Like charges repel and unlike charges attract each other.

#### **Coulomb's Law**

$$F \propto (q_1q_2)/r^2$$

The electrostatic force of attraction or repulsion between a pair of charges is directly proportional to the product of the charges and inversely proportional to the square of the distance between them.

$$F = (Kq_1q_2)/r^2$$

K is the constant of proportionality and is equal to  $9 \times 10^9 \text{ Nm}^2/\text{C}^2$  for free space.

For similar charges the force is repulsive and for dissimilar charges it is attractive.

#### **Charge Conservation**

When an ebonite rod is rubbed with fur, the ebonite rod acquires negative charge and the fur acquires positive charge. This means electrons have moved from fur to ebonite. The net charge in the system remains the same. So charges are neither created nor destroyed but transferred from one material to the other.

#### **Insulators and Conductors**

Insulators are bad conductors of charges but they can be charged easily by friction.

Conductors allow free flow of charges.

#### **Current**











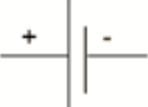

Current is the rate of flow of charge.

If q is the charge in coulomb and t is the time in seconds then current  $I=q/t$

The SI unit of current is ampere (A).

Current is a scalar quantity.

**Symbols used in electric circuit**

<b>Electric Component</b>	<b>Function/Description</b>	<b>Symbol</b>
Connecting wire	A connecting wire is represented by a straight line. It is usually made of copper and is provided with insulation to make electrical connections between two points.	
Resistor	The resistor is represented by a zig-zap line. Two thick dots at the ends represent brass terminals to which a wire is fixed. The resistor wire is generally made from alloys, such as nichrome, manganin, constantan and eureka.	
Cell	A thin long line represents the positive terminal of a cell, whereas thick and short line represents negative terminal of the cell. Source of electrical current.	
Fuse	To limit the current in an electric circuit	
Plug key	To make or break electric circuit for long time	Open key  Closed key 
Battery	A combination of two or more cells. Here the cells are arranged in series. Source of electrical current.	
Electric bulb	An electric device, such as incandescent lamp, is lamp, glow lamp, or fluorescent lamp that emits light when voltage is applied across the terminals.	
Connecting wires	Wires connected together	
Connecting wires	Wires crossing without being connected	
Voltmeter	It is a device used for measuring potential difference between two points in an electric circuit	
Ammeter	It is a device used for measuring current in an electric circuit	
Alternating current	A current which changes its direction rapidly on its own is called alternating current.	

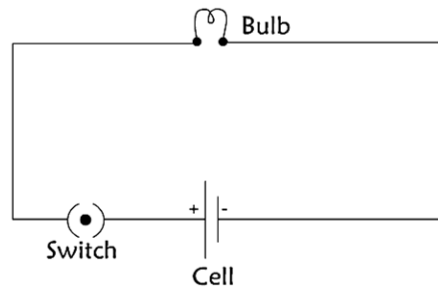

A diagram which shows how different components in a circuit have been connected using conventional symbols for the components is called a circuit diagram.

### **Electrical Potential**

Electric potential is the work done in carrying a unit positive charge from infinity to a point.

If  $W$  is the work done  $q$  is the charge, then electric potential  $V = W/q$

The SI unit of electric potential is Volts (V)

### **Electric Potential Difference**

The electric potential difference between two points is the work done in carrying a unit positive charge from one point to the other.

The electric potential difference between points A and B

$V_{AB} = \text{Work done to carry charge } q \text{ from A to B} / \text{charge } q$

The SI unit of electric potential difference is Volts (V)

### **Electric Potential energy**

Electric potential energy is the work which has to be done to bring charges to their respective locations against the electric field with the help of a source of energy.

This work done is stored in the form of potential energy of the charges.

### **Ohm's Law**

Under similar physical conditions, the current flowing through a wire is directly proportional to the difference in potential applied across its ends.

$I \propto V$

$V = I \times R$ , where  $R$  is the resistance offered.

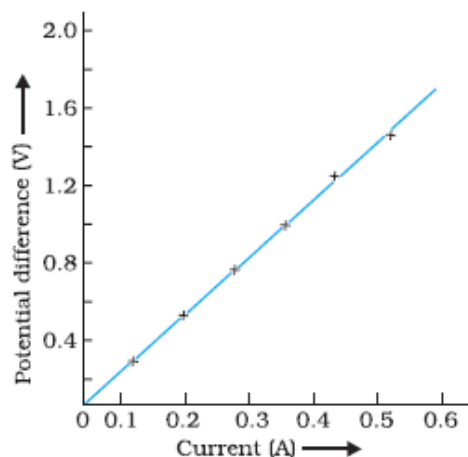

### Resistance

Resistance is the opposition to the flow of current.

The SI unit of resistance is OHM ( $\Omega$ )

1 ohm is the resistance offered by a wire carrying 1 A current when 1 V is applied across its ends.

### Factors Affecting Resistance

The resistance of a conducting wire depends on:

Nature of the material of the wire (Resistivity-  $\Omega$ )

Length of the wire ( $l$ )

Cross-sectional area of the wire ( $A$ )

$$R = \Omega (l/A)$$

### Resistivity

The resistance offered by a wire of unit length and unit cross-sectional area is called resistivity.

The SI unit of resistivity is ohm-meter ( $\Omega - m$ ).

Resistivity is also referred to as specific resistance.

Reciprocal of resistivity is called conductivity.

Conductivity,  $\Omega = 1/\Omega \Omega$ .

SI unit of conductivity is  $\text{ohm}^{-1} \text{m}^{-1}$  or  $\text{mho-m}^{-1}$

### Effect of Temperature

The resistivity of a conductor increases linearly with increase in temperature.

The resistivity of an insulator increases with increase in temperature.

The resistivity of a semiconductor decreases with increase in temperature.

Resistivity of an alloy increases with increase in temperature.

### Semiconductors and Superconductors

Materials having resistivity between that of an insulator and a conductor are called semiconductors.

Materials which lose their resistivity at low temperatures are called super conductors.

### Resistances in Series

If resistances  $R_1$ ,  $R_2$  and  $R_3$  are connected in series the equivalent resistance  $R_s = R_1 + R_2 + R_3$

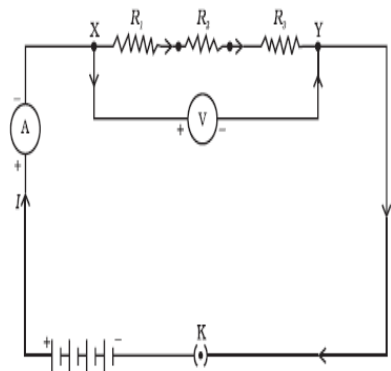

### Resistances in Parallel

If resistances  $R_1$ ,  $R_2$  and  $R_3$  are connected in parallel the equivalent resistance  $R_p$  is given by  $\frac{1}{R_p} = (1/R_1) + (1/R_2) + (1/R_3)$

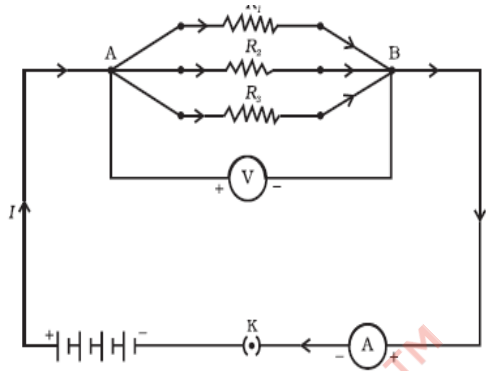

### Electrical Energy

Because of the existence of resistance to the flow of current work has to be done in order to maintain the flow of current.

Since the potential difference  $V$  is the work done to carry unit positive charge from infinity to a point, the work done to carry a charge  $q$  is given by:

$$W = qV$$

But  $I = q/t$

So  $W = ItV$

Since  $V = IR$

$$W = I^2Rt = V^2t/R$$

This work done is stored as energy.

SI unit of electrical energy is Joule.

### Joule's Law of Heating

When a current  $I$  flows through a resistor  $R$  heat is produced.

$H = I^2Rt$ , this is Joule's law of heating.

### Electric Power

The rate at which electric energy is consumed is called electric power.

Power = work done/time.

$$P = W/t = V \times I = I^2 R = V^2/R$$

SI unit of electric power is Watt.

### Calculation of Power for House Hold Electricity

Kilowatt hour (kWh) is the commercial unit for electrical energy

$$1 \text{ kWh} = 3.6 \times 10^6 \text{ J}$$

No. of units of electricity consumed in a household = no. of kWh

Total cost of electricity = total units  $\times$  cost per unit of electricity

**Fuse Wire**

The wire which melts, breaks the circuit and prevents the damage of various appliances in household connections is called a fuse wire

A fuse wire is made of an alloy of aluminium, copper, iron and lead

The thickness of the fuse wire increases the maximum safe current that can flow through it

