

RD Sharma Solutions

Class 8 Maths

Chapter 25

Ex 25.1

D) Given data :-

Activities	sleep	school	home	play	others	Total
No. of hours	8	7	4	2	3	24

Total no. of hours = 24 hrs.

These total no. of hours are to be represented on a 360° circle.

Let the contribution of each hour on pie chart be x° .

\therefore Total no. of hours = 24 hrs.

$$\begin{aligned}\text{Total contribution} &= 24x^\circ \\ &\Rightarrow 360^\circ\end{aligned}$$

$$\text{L.H.S} = \text{R.H.S.}$$

$$24x = 360^\circ$$

$$x = \frac{360}{24}$$

$$\boxed{x = 15^\circ}$$

\therefore Contribution of each hour spent on pie chart is 15° .

\therefore for

sleeping	$\Rightarrow 8x$	$\Rightarrow 120^\circ$
school	$\Rightarrow 7x$	$\Rightarrow 105^\circ$
home	$\Rightarrow 4x$	$\Rightarrow 60^\circ$
play	$\Rightarrow 2x$	$\Rightarrow 30^\circ$
others	$\Rightarrow 3x$	$\Rightarrow 45^\circ$

\therefore The pie chart is given as



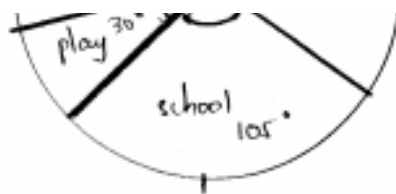

② Given data :-

Religion	Hindu	Muslim	Sikh	Christian	Total
No. of workers.	420	300	225	105	1080

Total no. of workers = 1080

These total no. of workers are to be represented on a 360° circle.

Let the contribution of each worker be x° on the chart.

Total no. of workers = 1080.

Total angle contribution = Total no. of workers \times contribution of each worker

$$\Rightarrow 1080x$$

$$\therefore \text{Total angle contribution} = 1080x \quad \text{--- (1)}$$

$$\text{But total angle} = 360^\circ \quad \text{--- (2)}$$

$$\text{(1)} = \text{(2)}$$

$$1080x = 360$$

$$x = \frac{1}{3}$$

\therefore Contribution of each worker on pie chart is $\frac{1}{3}$.

$$\begin{aligned} \therefore \text{Contribution of Hindu workers} &= 420 \times x \\ &= 420 \times \frac{1}{3} \end{aligned}$$

$$\text{Contribution of Hindu workers} = 140^\circ$$

$$\text{Contribution of muslim workers} = \text{Total no. of workers} \times \text{Contribution of each worker}$$

$$\Rightarrow 300 \times \frac{1}{3}$$

$$\text{Contribution of muslim workers} = 100^\circ$$

$$\begin{aligned} \text{Similarly, Sikh workers} &= 225 \times x \\ &= 225 \times \frac{1}{3} \end{aligned}$$

$$\text{Sikh workers} = 75^\circ$$

$$\begin{aligned} \text{Christian workers} &= 105 \times x \\ &= 105 \times \frac{1}{3} \end{aligned}$$

$$\text{Christian workers} = 35^\circ$$

∴ The pie chart is given as

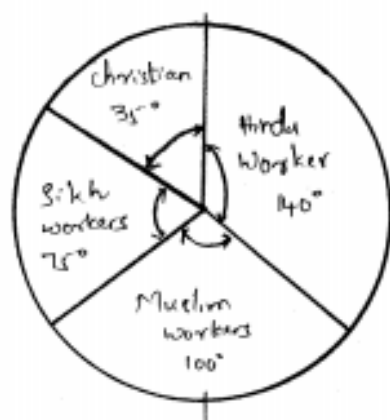

③ Given data

Items	Ordinary bread	fruit bread	cakes & pastries	B. units	others	Total
Sales (Rs)	260	40	100	60	20	480.

Total value of sales in one day = 480Rs

This total value is to be represented on a 360° circle

Let the contribution of each rupee on pie chart be x° .

Total value of sales = Rs. 480

∴ Total contribution of sales on pie chart

⇒ Total value \times Contribution of each rupee

⇒ $480 \times x$

⇒ $480x$ — ①

∴ But total angle. = $360^\circ \rightarrow$ ②

$$\therefore \text{①} = \text{②}$$

$$\Rightarrow 480x = 360$$

$$x = \frac{360}{480}$$

$$x = \frac{3}{4}^\circ$$

∴ Contribution of each rupee on pie chart = $\frac{3}{4}^\circ$.

∴ Contribution of ordinary bread sales on pie chart

\Rightarrow sales \times contribution of each rupee

$$\Rightarrow 260 \times \frac{3}{4}$$

$$\Rightarrow 195^\circ.$$

Similarly contribution of

$$\text{fruit bread} = \text{sales} \times x$$

$$= 40 \times \frac{3}{4}$$

$$= 30^\circ$$

$$\text{cakes \& pastries} = 100 \times x$$

$$= 100 \times \frac{3}{4}$$

$$= 75^\circ$$

$$\text{Biscuits} = \text{sales of Biscuits} \times x \text{ (rupee contribution)}$$

$$= 60 \times \frac{3}{4}$$

$$\text{Biscuits} = 45^\circ$$

$$\begin{aligned} \text{Others} &= \text{sale value for others} \times \text{super. value} \\ &= 20 \times x \\ &= 20 \times \frac{3}{4} \end{aligned}$$

$$\text{others} = 15^\circ$$

∴ The pie chart is given by

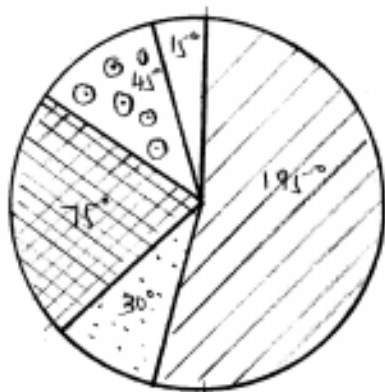

- ordinary bread
- cakes & pastries
- fruit bread.
- Biscuits.
- others.

④ Given data

items	Rent	Education	food	clothing	others.
Amount of expenditure (Rs)	2700	1800	2400	1500	2400

Total amount of expenditure

$$\Rightarrow 2700 + 1800 + 2400 + 1500 + 2400$$

$$\Rightarrow 1,08,00$$

$$\Rightarrow \text{Rs } 10,800$$

∴ Total amount of expenditure = 10,800 Rs

Let This amount is to be represented on a pie chart.

Let the contribution of each rupee on pie chart be x° .

∴ Total contribution of expenditure = Total expenditure \times contribution of each rupee
 $\Rightarrow 10,800 \times x$

∴ But total angle = 360°

$$\therefore 10800x = 360$$

$$x = \frac{360}{10800}$$

$$x = \frac{1}{30}^\circ$$

Contribution of each rupee on pie chart = $\frac{1}{30}^\circ$.

∴ Contribution of expenditures

$$\text{Rent} = 2700 \times x$$

$$= 2700 \times \frac{1}{30}$$

$$\text{Rent} = 90^\circ$$

$$\text{Education} = 1800 \times x$$

$$= 1800 \times \frac{1}{30}$$

$$\text{Education} = 60^\circ$$

$$\begin{aligned} \text{food} &= 2400 \times x \\ &= 2400 \times \frac{1}{30} \end{aligned}$$

$$\text{food} = 80^\circ$$

$$\begin{aligned} \text{clothing} &= 1500 \times x \\ &= 1500 \times \frac{1}{30} \end{aligned}$$

$$\text{clothing} = 50^\circ$$

$$\begin{aligned} \text{others} &= 2400 \times x \\ &= 2400 \times \frac{1}{30} \end{aligned}$$

$$\text{others} = 80^\circ$$

\therefore The pie chart is given as.

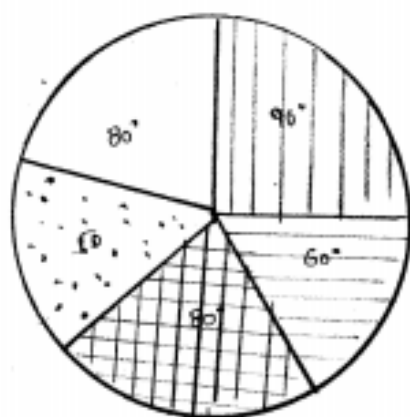

 - Rent

 - Education

 - food

 - clothing

 - others

⑤ Given data

Categories	Cultivators	Agri labourers	industry workers	commercial workers	Others
% of workers	40	25	12.5	10	12.5

$$\begin{aligned}\text{Total \% of worker} &= 40 + 25 + 12.5 + 12.5 + 10 \\ &= 100\%\end{aligned}$$

This 100% should be represented on a pie chart.

Let the contribution of 1% on pie chart be x° .

$$\begin{aligned}\therefore \text{Total contribution} &= \text{Total \%} \times \text{contribution of 1\%} \\ &= 100 \times x \\ &= 100x \quad \text{--- (1)}\end{aligned}$$

$$\therefore \text{But total angle} = 360^\circ \quad \text{--- (2)}$$

$$\therefore 100x = 360 \quad \{ \because (1) = (2) \}$$

$$\boxed{x = 3.6^\circ}$$

\therefore Contribution of 1% on pie chart is 3.6° .

\therefore Contribution of

$$\begin{aligned}\rightarrow \text{Cultivators} &= \% \text{ of workers} \times x \\ &= 40 \times x \\ &= 144^\circ\end{aligned}$$

Agricultural labourers

$$\Rightarrow \% \text{ of workers} \times \pi$$

$$\Rightarrow 25 \times 3.6$$

$$\Rightarrow 90^\circ$$

Industrial workers $\Rightarrow \%$ of workers $\times \pi$

$$\Rightarrow 12.5 \times 3.6$$

$$\Rightarrow 45^\circ$$

Commercial workers $\Rightarrow \%$ of workers $\times \pi$

$$\Rightarrow 10 \times 3.6$$

$$\Rightarrow 36^\circ$$

others $\Rightarrow \%$ of workers $\times \pi$

$$\Rightarrow 12.5 \times 3.6$$

$$\Rightarrow 45^\circ$$

\therefore The pie chart is given by.

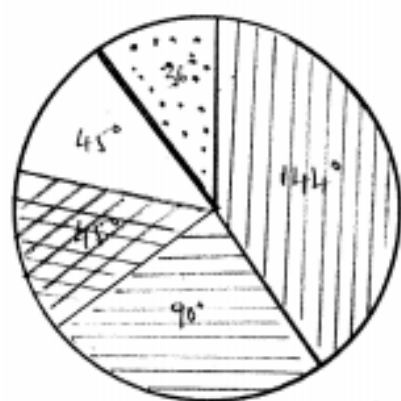

 - cultivators

 - agricultural workers

 - industrial workers

 - others

 - commercial workers

⑥ Given data.

Items	Paper	Printing	Binding	Advertising	Miscellaneous
Expenditure (in %)	35%	20%	10%	5%	30%

Total Expenditure 100% to be represented on a pie chart.

Let 1% expenditure be contribution on pie chart

be x° .

\therefore Total contribution = Total Expenditure \times Contribution of 1% expenditure

$$\Rightarrow 100x$$

$$\text{Total angle} = 360^\circ$$

$$\therefore 100x = 360$$

$$\boxed{x = 3.6^\circ}$$

Contribution of 1% Expenditure is 3.6° on pie chart.

\therefore Contribution of

$$\begin{aligned}\text{Paper expenditure} &= 35 \times x \\ &= 35 \times 3.6 \\ &= 126^\circ\end{aligned}$$

$$\begin{aligned}\text{Printing expenditure} &= 20 \times x \\ &= 72^\circ\end{aligned}$$





$$\begin{aligned} \text{Binding expenditure} &= 10 \times x \\ &= 36^\circ \end{aligned}$$

$$\begin{aligned} \text{Advertising expenditure} &= 5 \times x \\ &= 18^\circ \end{aligned}$$

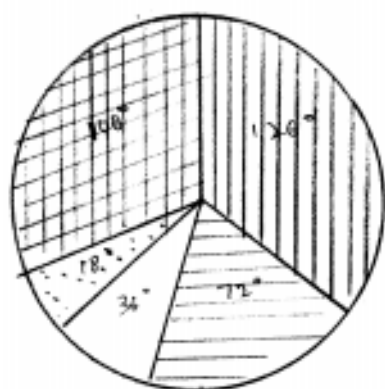
$$\begin{aligned} \text{Miscellaneous} &= 30 \times x \\ &= 108^\circ \end{aligned}$$

∴ The given pie chart is :-



-  - paper expenditure
-  - printing
-  - miscellaneous
-  - Advertising
-  - Binding.

① Given data

Items	wheat	pulses	Janwar	Grainfruits	vegetables	Total
%	$\frac{125}{3}$	$\frac{125}{6}$	$\frac{25}{2}$	$\frac{50}{3}$	$\frac{25}{3}$	100

100% should be represented on a pie chart.

x° be contribution of each % on pie chart

$$\therefore \text{Total contribution} = 100\% \times x \\ = 100x^\circ$$

$$\text{But total angle} = 360^\circ$$

$$\therefore 100x = 360$$

$$x = 3.6$$

contribution of 1% on pie chart is 3.6° .

\therefore Contribution of

$$\text{wheat} = \frac{125}{3} \times x$$

$$= \frac{125}{3} \times 3.6$$

$$\text{wheat} = 150^\circ$$

$$\text{pulses} = \frac{125}{6} \times x$$

$$= \frac{125}{6} \times 3.6$$

$$= 75^\circ$$

$$\text{Jawar} = \frac{25}{2} \times x$$

$$= 45^\circ$$

$$\text{Groundnut} = \frac{50}{3} \times x$$





$$= \frac{50}{3} \times 3.6$$

$$= 60^\circ$$

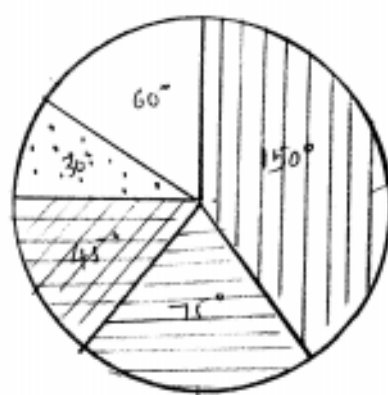
$$\begin{aligned} \text{Vegetables} &= \frac{25}{3} \times 3.6 \\ &= 30^\circ \end{aligned}$$

∴ The pie chart is given as.



-  - wheat
-  - pulses
-  - jowar
-  - vegetables
-  - grains

⑧ Given data

Items	food	clothing	rent	Education	Unforeseen events	medicine
Expenditure (%)	40%	20%	10%	10%	15%	5%

$$\text{Total \%} = 100\%$$

100% is to be represented on a pie chart.
 Let x° be the contribution of each % on pie chart.

$$\begin{aligned} \therefore \text{Total Contribution} &= \text{Total \%} \times x \\ &= 100\% \times x \end{aligned}$$

∴ The given pie chart is given by

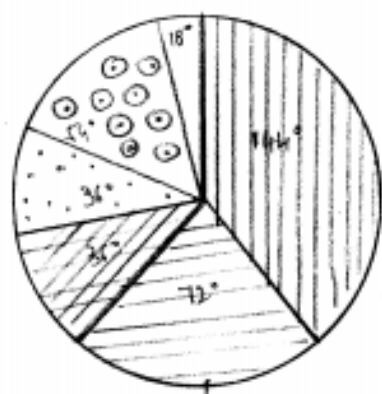

- ▨ - food expenses
- ▧ - clothing
- ▩ - rent expenses
- ⋮ - education
- ⊗ - Unforeseen events
- - medicine.

3) Given data

Continents	Asia	USSR	Africa	Europe	N.Amer	S.America	Austr
Area (km ²)	26.9	20.5	30.3	4.9	24.3	17.9	8.5

$$\text{Total area} = 26.9 + 20.5 + 30.3 + 4.9 + 24.3 + 17.9 + 8.5$$

$$\text{Total area} = 133.3 \text{ km}^2 \text{ (million km}^2\text{)}$$

Total area to be represented on pie chart

Let x° be contribution of 132 million area

on pie chart

$$\begin{aligned} \therefore \text{Total } \% \text{ contribution} &= \text{Total area} \times \frac{\text{contribution of}}{1 \text{ km}^2 \text{ area}} \\ &= 133.3 \times x^\circ \\ &= 133.3x^\circ \end{aligned}$$

But total angle $= 360^\circ$

$$\therefore 133.3x = 360$$

$$x = \frac{360^\circ}{133.3}$$

\therefore Contribution of each square million km is $\frac{360^\circ}{133.3}$

\therefore Contribution of

$$\begin{aligned} \text{Asia} &= 26.9x \\ &= 26.9 \times \frac{360}{133.3} \end{aligned}$$

$$\text{Asia} = 72.64^\circ$$

$$\text{USSR} = 20.5 \times \frac{360}{133.3}$$

$$= 55.36^\circ$$

$$\text{Africa} = 30.3 \times \frac{360}{133.3}$$

$$\text{Africa} = 81.83^\circ$$

$$\text{Europe} = 4.9 \times \frac{360}{133.3}$$

$$= 13.23^\circ$$

$$\text{North America} = 24.3 \times \frac{360}{133.3}$$

$$= 65.62^\circ$$

$$\text{South America} = 17.9 \times \frac{360}{1333}$$

$$= 48.34^\circ$$

$$\text{Australia} = 8.5 \times \frac{360}{1333}$$

$$= 22.95^\circ$$

The pie chart is given as:-

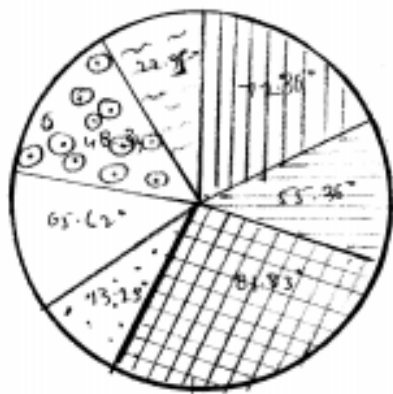

||||| - Asia

===== - USSR

||||| - Africa

||:| - Europe

□ - North America

||||| - South America

||||| - Australia

10) Given data

Items	Cement	Timber	Bricks	Labour	Steel	Miscellaneous
Expenditure (in 1000Rs)	60	30	45	75	45	45

$$\text{Total Expenditure} = 60 + 30 + 45 + 75 + 45 + 45$$

$$= \text{Rs } 300,000$$

Rs 300 thousand to be represented on a pie chart

let x° be contribution by each ~~100~~ thousand
Rupee on pie chart.

$$\therefore \text{Total contribution} = 300 \times x^\circ$$

$$\text{But total angle} = 360^\circ.$$

$$\therefore 300 \times x = 360^\circ$$

$$\boxed{x = 1.2^\circ}$$

\therefore The contribution of each thousand rupee on pie
chart is 1.2° .

\therefore The contribution of

$$\begin{aligned} \text{Cement} &= 60 \times x \\ &= 72^\circ \end{aligned}$$

$$\begin{aligned} \text{Timber} &= 30 \times x \\ &= 36^\circ \end{aligned}$$

$$\begin{aligned} \text{Bricks} &= 45 \times x \\ &= 54^\circ \end{aligned}$$

$$\begin{aligned} \text{Labour} &= 75 \times x \\ &= 90^\circ \end{aligned}$$

$$\begin{aligned} \text{Sped} &= 45 \times x \\ &= 54^\circ \end{aligned}$$

$$\begin{aligned} \text{Miscellaneous} &= 45 \times x \\ &= 45 \times 1.2 \\ &= 54^\circ \end{aligned}$$

The pie chart is given by.

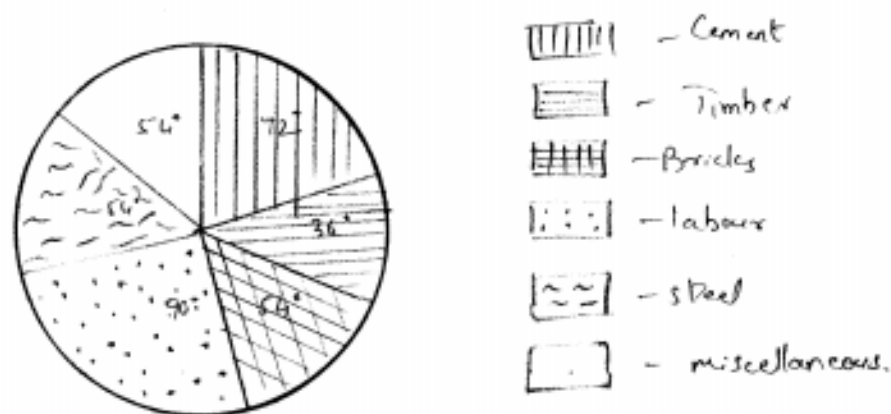

(ii) Given data

Items	food	Entertainment	Other expenditure	Savings
Expenditure (%)	40	25	20	15

$$\text{Total Expenditure} = 100\%$$

Let x° be contribution of 1% Expenditure on pie chart.

\therefore Total contribution on pie chart = 100%

But total angle = 360°

$$\therefore 100\% = 360^\circ$$

$$\boxed{x = 3.6^\circ}$$

\therefore Contribution of each % on pie chart is 3.6°

\therefore Contribution of

$$\begin{aligned}\text{food} &= 40\% \times x \\ &= 40 \times 3.6 \\ &= 144^\circ\end{aligned}$$

$$\begin{aligned}\text{Entertainment} &= 25\% \times x \\ &= 25 \times 3.6 \\ &= 90^\circ\end{aligned}$$

$$\begin{aligned}\text{other expenditure} &= 20\% \times x \\ &= 20 \times 3.6 \\ &= 72^\circ\end{aligned}$$

$$\begin{aligned}\text{Savings} &= 15\% \times x \\ &= 15 \times 3.6 \\ &= 54^\circ\end{aligned}$$

The pie chart is given as:-

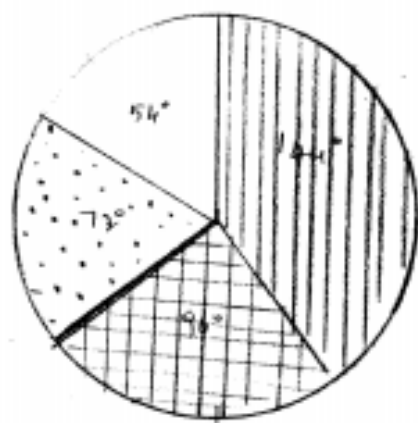

-  - food
-  - Entertainment
-  - other exp.
-  - Savings

⑬ Given data

Printing	paper	Binding charges	Advertiser's emol.	Royalty	Miscellaneous
30%	15%	15%	20%	10%	15%

Total % = 105%

105% is to be contributed on a pie chart.

Let 1% contribution on pie chart be x° .

\therefore Total contribution = $(105\% \times x^\circ)$

But total angle = 360° .

$$105x^\circ = 360^\circ$$

$$\boxed{x = \frac{24}{7}}$$

Contribution of 1% on pie chart is $\frac{24}{7}$.

\therefore Contribution of

$$\begin{aligned}\text{Printing} &= 30 \times x^\circ \\ &= 30 \times \frac{24}{7} \\ &= 102.85^\circ\end{aligned}$$

$$\begin{aligned}\text{paper} &= 15 \times x^\circ \\ &= 51.42^\circ\end{aligned}$$

$$\begin{aligned} \text{Binding charges} &= 15 \times x^{\circ} \\ &= 15 \times \frac{24}{7} \\ &= 51.42^{\circ} \end{aligned}$$





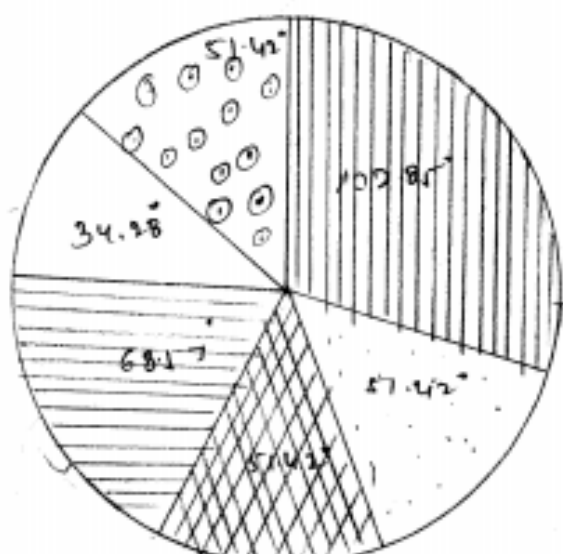

$$\begin{aligned} \text{Advertisement} &= 20 \times x^{\circ} \\ &= 68.57^{\circ} \end{aligned}$$

$$\begin{aligned} \text{Royalty} &= 10 \times x^{\circ} \\ &= 34.28^{\circ} \end{aligned}$$

$$\begin{aligned} \text{Miscellaneous} &= 15.1 \times x^{\circ} \\ &= 15 \times \frac{24}{7} \\ &= 51.42^{\circ} \end{aligned}$$

∴ The pie chart is given as.



-  - printing
-  - paper
-  - advertising
-  - Advertising
-  - Royalty
-  - Miscellaneous

(14) Given data.

Items	wheat	Rice	Tea
production (metric tons)	3260	1840	900

$$\begin{aligned}\text{Total production} &= 3260 + 1840 + 900 \\ &= 6000 \text{ Ton}^3.\end{aligned}$$

This total production is to be represented on a pie chart.

Let contribution of 1 metric ton on pie chart be x° .

$$\text{Total contribution} = 6000x^\circ.$$

$$\text{But total angle} = 360^\circ$$

$$6000x^\circ = 360^\circ.$$

$$x^\circ = \frac{360}{6000}$$

$$\boxed{x = 0.06^\circ}$$

\therefore Contribution of each metric ton on pie chart is 0.06° .

\therefore Contribution of



$$\begin{aligned}\text{wheat} &= 3260 \times x \\ &= 3260 \times 0.06 \\ &= 195.6^\circ.\end{aligned}$$

$$\begin{aligned}\text{Rice} &= 1840 \times \pi \\ &= 1840 \times 0.06 \\ &= 36.8^\circ \\ &= 110.4^\circ\end{aligned}$$

$$\begin{aligned}\text{Tea} &= 900 \times \pi \\ &= 900 \times 0.06 \\ &= 54\end{aligned}$$

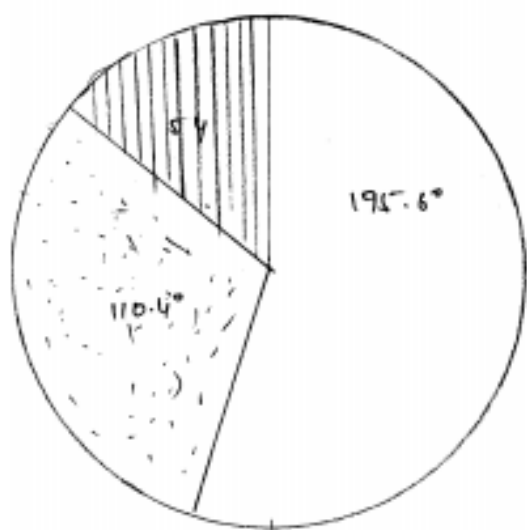
The pie chart is given as.



-  - wheat
-  - rice
-  - tea.

16) Given

percentages 12.6%, 18.2%, 17.5%, 20.3%, 2.8%,
4.2%, 9.8%, 14.7%.

Total percentage = 100.1%.

This percentage is to be represented by on a pie chart.

∴ let x° be contribution of each % on pie chart.

∴ Total contribution = $100.1 \times x^\circ$.

But total angle = 360° .

$$\therefore 100.1x^\circ = 360^\circ$$

$$x^\circ = \frac{360}{100.1}$$

$$x^\circ = \frac{3600^\circ}{100.1}$$

∴ Contribution of each % on pie chart is $\frac{3600^\circ}{100.1}$.

∴ Contribution of

$$12.6\% \Rightarrow 45.31^\circ.$$

$$18.2\% = 18.2 \times \frac{3600}{100.1}$$
$$= 65.41^\circ.$$

$$17.5\% = 17.5 \times \frac{3600}{100.1}$$
$$= 62.68^\circ.$$

$$20.3\% = 20.3 \times \frac{360}{100}$$

$$= 73.08^\circ$$

$$2.8\% = 2.8 \times \frac{360}{100}$$

$$= 10.08^\circ$$

$$4.2\% = 4.2 \times \frac{360}{100}$$

$$= 15.104^\circ$$

$$9.8\% = 9.8 \times \frac{360}{100}$$

$$= 35.28^\circ$$

$$14.7\% = 14.7 \times \frac{360}{100}$$

$$= 52.86^\circ$$

The pie chart is given as

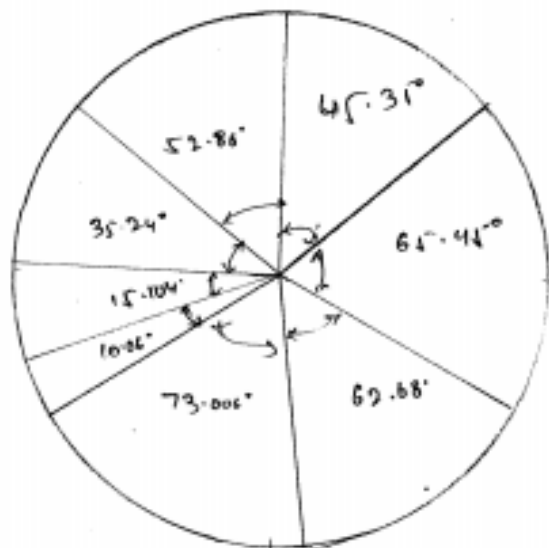

⑩ Given data

Items	food	clothing	rent	education	fuel	Medicine
Expenditure (Rs)	1600	200	600	150	100	80
					Miscellaneous	
					270	

Total expenditure = 3000 Rs.

This total expenditure is to be represented on a pie chart.

Let contribution of each rupee be x° on pie chart.

Total contribution = $3000x^\circ$.

But, total angle = 360° .

$$\therefore 3000x^\circ = 360^\circ$$

$$x = \frac{3}{25}^\circ$$

The contribution of each rupee on pie chart is $\frac{3}{25}^\circ$.

\therefore The contribution of

$$\begin{aligned}\text{food} &= 1600 \times x^\circ \\ &= 1600 \times \frac{3}{25} \\ &= 192^\circ\end{aligned}$$

$$\begin{aligned}\text{clothing} &= 200 \times x^\circ \\ &= 200 \times \frac{3}{25} \\ &= 24^\circ\end{aligned}$$

$$\begin{aligned}\text{Rent} &= 600 \times x^\circ \\ &= 600 \times \frac{3}{25} \\ &= 72^\circ\end{aligned}$$

$$\begin{aligned}\text{Education} &= 150 \times x^\circ \\ &= 150 \times \frac{3}{25} \\ &= 18^\circ\end{aligned}$$

$$\begin{aligned}\text{fuel} &= 100 \times x^\circ \\ &= 100 \times \frac{3}{25} \\ &= 12^\circ\end{aligned}$$

$$\begin{aligned}\text{Medicine} &= 80 \times x^\circ \\ &= 80 \times \frac{3}{25} \\ &= 9.6^\circ\end{aligned}$$

$$\begin{aligned}\text{Miscellaneous} &= 270 \times x^\circ \\ &= 270 \times \frac{3}{25} \\ &= 32.4^\circ\end{aligned}$$

The pie chart is given as.

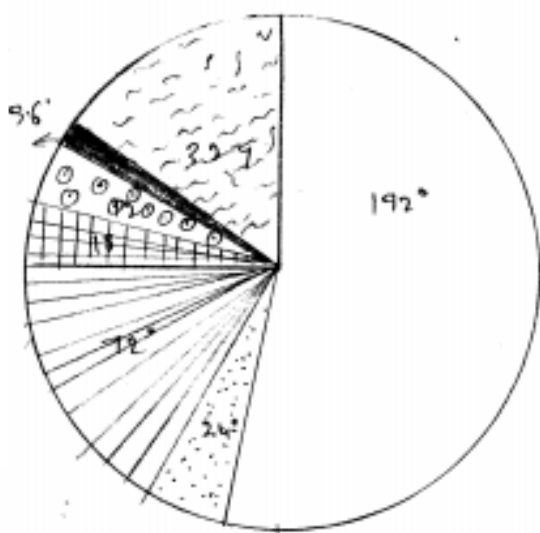

-  - food
-  - rent
-  - Education
-  - fuel
-  - medicine
-  - miscellaneous
-  - clothing

17) Given data

Agriculture	irrigation & power	small industries	transport	social service	miscellaneous
14%	16%	29%	17%	16%	8%

Total % = 100% is to be represented on pie chart

let x be contribution of each % on pie chart.

$$\therefore \text{Total contribution} = 100\% \times x = 100x$$

But total angle = 360.

$$\therefore 100x = 360$$

$$\boxed{x = 3.6^\circ}$$

Contribution of
 agriculture = $14\% \times 360^\circ$
 = 14×36
 = 50.4°

irrigation = $16\% \times 360^\circ$
 = 57.6°

small industries = $29\% \times 360^\circ$
 = 104.4°

transport = $17\% \times 360^\circ$
 = 17×36
 = 61.2°

social service = $16\% \times 360^\circ$
 = 57.6°

miscellaneous = $8\% \times 360^\circ$
 = 8×36
 = 28.8°

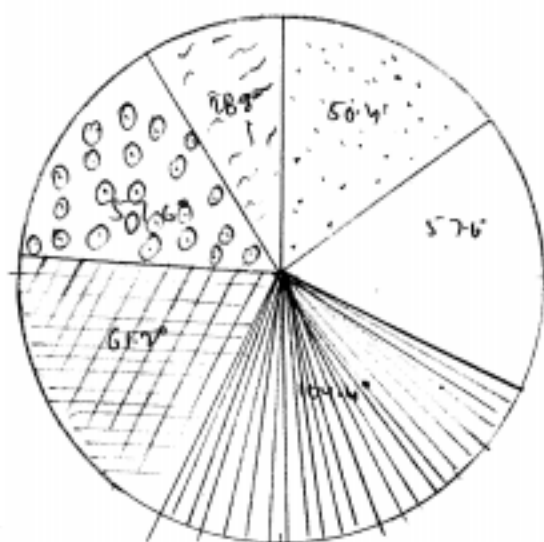

-  - irrigation
-  - small industries
-  - transport
-  - social service
-  - miscellaneous
-  - agriculture

3) Given data

angles of pie chart.

$$\text{steel} = 45^\circ, \text{labour} = 100^\circ$$

$$\text{Timber} = 100^\circ, \text{cement} = 75^\circ$$

$$\text{Brick} = 50^\circ$$

$$\boxed{\text{Total angle} = 370^\circ}$$

Expenditure incurred on cement is Rs 112500

i.e. for 75° cost incurred is 112500

$$\therefore \text{Total cost} = \frac{370}{75} \times 112500$$

$$\boxed{\text{Total cost} = 55,500 \text{ Rs}}$$

Expenditure incurred on labour

$$= \frac{100}{370} \times \text{Total cost}$$

$$= \frac{100}{370} \times 55,500$$

$$= 15,000 \text{ Rs.}$$

$$\boxed{\therefore \text{Expenditure incurred on labour is Rs 15,000}}$$

② Given angles of pie chart

Maize - 30°

wheat - 120° , Gram - 50° , Rice - 60° , sugar - 100° .

Given total production = 81,000 tonnes.

i.e. total production $\propto 360^\circ \rightarrow 81,000$ tonnes

$$\therefore \boxed{1^\circ \rightarrow \frac{81,000}{360^\circ}}$$

$$\begin{aligned} \text{production of wheat} &= 120 \times \frac{81,000}{360} \\ &= 27,000 \text{ tonnes.} \end{aligned}$$

$$\begin{aligned} \text{production of sugar} &= 100 \times \frac{81,000}{360} \\ &= 22,500 \text{ tonnes.} \end{aligned}$$

$$\begin{aligned} \text{production rice} &= 60 \times \frac{81,000}{360} \\ &= 13,500 \text{ Tonnes} \end{aligned}$$

$$\begin{aligned} \text{production of maize} &= 30 \times \frac{81,000}{360} \\ &= 6,750 \text{ Tonnes.} \end{aligned}$$

$$\begin{aligned} \text{production of gram} &= 50 \times \frac{81,000}{360} \\ &= 11,250 \text{ Tonnes.} \end{aligned}$$

③ Given

no. of students = 1000
for science

per angles for

$$\text{science} = 100^\circ$$

$$\text{arts} = 120^\circ$$

$$\text{commerce} = 65^\circ$$

$$\text{law} = 45^\circ$$

$$\text{Education} = 95^\circ$$

$$\therefore \text{no. of students for science} \Rightarrow 100^\circ \text{ for } 1000$$
$$100^\circ \rightarrow 1000$$

$$\text{total no. of students} \rightarrow 360^\circ$$

$$100^\circ \rightarrow 1000$$

$$360^\circ \rightarrow x$$

$$\therefore x = \frac{360 \times 1000}{100}$$

$$\boxed{x = 3600}$$

$$\text{Total no. of students} = 3600$$

$$\text{no. of students of arts} = \frac{120}{360} \times 3600$$
$$= 1200$$

$$\text{ratio of students in science \& arts} = \frac{\text{no. of science students}}{\text{no. of arts students}}$$
$$= \frac{1000}{1200}$$
$$= (5/6)$$

$$\text{ratio of science \& arts students} = 5:6.$$

④ Given total marks = 440.

Given angles of pie chart

$$\text{maths} = 108^\circ$$

$$\text{science} = 81^\circ$$

$$\text{English} = 72^\circ$$

$$\text{Hindi} = 54^\circ$$

$$\text{Social science} = 45^\circ$$

$$\text{Total marks} \Rightarrow 360^\circ \rightarrow 440$$

$$\text{marks in maths} = \frac{108}{360} \times 440$$

$$= 132$$

$$\text{marks in science} = \frac{81}{360} \times 440$$

$$= 99$$

$$\text{marks in English} = \frac{72}{360} \times 440$$

$$= 88$$

$$\text{marks in Hindi} = \frac{54}{360} \times 440$$

$$= 66$$

$$\text{marks in Social} = \frac{45}{360} \times 440$$

$$= 55$$

③ Given

students scored in maths = 135

pie chart angles

Maths - 90° Hindi - 60°

Science - 76°

social - 72°

English - 62°

$$\text{Maths score} = \frac{90}{360} \times \text{Total marks} = 135$$

$$\begin{aligned}\therefore \text{Total marks} &= 135 \times 4 \\ &= 540\end{aligned}$$

$\therefore \text{Total marks scored} = 540$

$$\begin{aligned}\text{Marks in science} &= \frac{76}{360} \times 540 \\ &= 114\end{aligned}$$

$$\begin{aligned}\text{marks in social} &= \frac{72}{360} \times 540 \\ &= 108\end{aligned}$$

$$\begin{aligned}\text{marks in English} &= \frac{62}{360} \times 540 \\ &= 93\end{aligned}$$

$$\begin{aligned}\text{marks in Hindi} &= \frac{60}{360} \times 540 \\ &= 90\end{aligned}$$